

CO2 and O2 Monitor Operating Instructions

Model: ZGa21

Table of Contents

1. Product Instruction
2. Package Content Check & Main Unit View
3. LCD Display Symbol
4. SEU (Sensor Unit) Function Instruction
5. RDU (Remote Display Unit) Function Instruction
6. Safety Note
7. Caring For Product
8. Installation Instruction
9. Customizing Settings
10. CO2 & O2 & Temperature Specification
11. Weight & Dimension
12. Fault Codes & Troubleshooting Guide

1. Product Instruction

Thank you for selecting the ZGa21 CO2 and O2 Monitor. It is designed to detect the presence of Carbon Dioxide and Oxygen in the ambient air to protect people in confined spaces. High concentrations of CO2 or low concentrations of Oxygen in confined spaces are dangerous, and may lead to health problems ranging from headaches and fatigue to asphyxiation and death. The ZGa21 CO2 & O2 Monitor is with the audible alarm and visual indication which will activate when CO2 or O2 concentration reaches the pre-set level. Detection of high levels of CO2 will also activate relay that could be used for a fan or air-conditioning system to ventilate the confined space, and reduce CO2 concentration and add O2 concentration in the area. The ZGa21 CO2 & O2 Monitor can be widely used in CO2 storage areas, breweries, wineries, cellars, beverage dispensing areas, and fast food outlets.

ZGa21 CO2 & O2 Monitor is cost-effective and has many features:

1. Dual Beam NDIR (Non-Dispersive Infrared) technology is used to measure CO2 concentration up to 50,000ppm (parts per million) and electrochemical technology to measure O2 concentration up to 30%.
2. With the SEU (Sensor Unit) and RDU (Remote Display Unit), it can connect up to 3 RDU for safety notices.
3. Large digital LCD display clearly indicates the ambient CO2& O2 concentration.
4. Relay output can automatically control a fan to ventilate confined spaces.
5. Audible and visual alarm indications.
6. IP54 Water Proof Protection of SEU (Sensor Unit).

2. Package Content Check & Main Unit View

The ZGa21 package comprises the following parts:

Main Unit:

SEU(Sensor Unit)	RDU (Remote Display Unit)	Panel holders
User manual	8 meters (26 feet) communication cable	

Accessories:

Plug lock	1 pcs	Screw	10pcs	Expansion plug	10 pcs
Nail cable clip	10 pcs	Warning paper	1 pcs		

SEU (Sensor Unit)

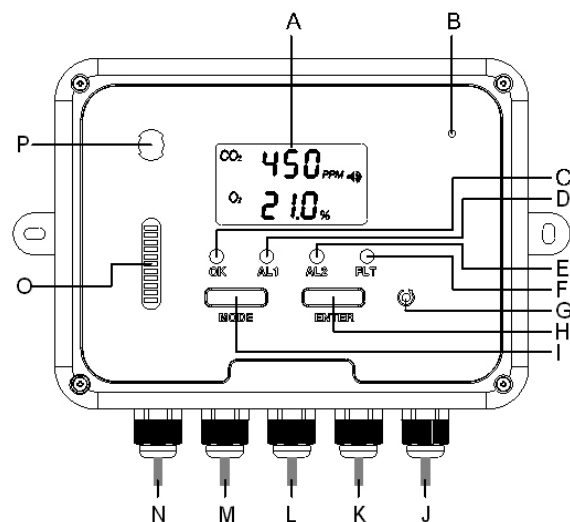

- A. LCD display
- B. Buzzer
- C. Green LED (Power system indication)
- D. Red 1 LED(AL1)
- E. Red 2 LED(AL2)
- F. Yellow LED(Fault indication)
- G. Reset Button
- H. Enter Button
- I. Mode Button
- J. CO2 Relay output (red& white: NO, blue& white: NC)
- K. O2 Relay output (red& white: NO, blue& white: NC)
- L. Analog output(red&white:CO2, blue &white: O2)
- M. Communication Cable to RDU
- N. Power Supply
- O. CO2 entry
- P. O2 entry

RDU (Remote Display Unit)

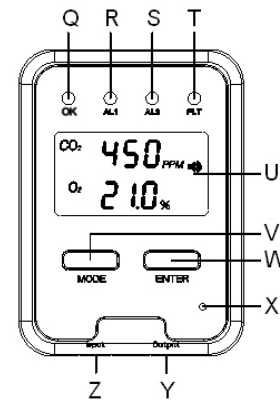

- Q. Green LED (Power system indication)
- R. Red 1 LED (AL1)
- S. Red 2 LED (AL2)
- T. Yellow LED (Fault indication)
- U. LCD display
- V. Mode Button
- W. Enter Button
- X. Buzzer
- Y. RJ45 Plug for next RDU (Output)
- Z. RJ45 Plug for SEU(Input)

3. LCD Display Symbol

Symbol	Meaning	Description
450 ppm	CO2 Concentration ppm (Parts Per Million)	ambient CO2 concentration
21.0%	O2 Concentration	ambient O2 concentration
	Alarm	alarm icon
DIAG	Diagnose	Test communications between the SEU and RDU
AL1	CO2/O2 First Alarm level	The relay will be triggered when CO2 concentration exceeds the first alarm level or O2 concentration drops the first alarm level, the Red 1 LED will flash, and buzzer will sound.
AL 2	CO2/O2 Second Alarm level	Safety Notice "ESC" displays on LCD when CO2 concentration exceeds the second alarm level or O2 concentration drops the second alarm level. The Red 1& Red 2 LEDs will flash, and buzzer will sound.
CALIBRATING	Calibration	To calibrate the CO2 sensor /O2 sensor when the accuracy deviates from the actual CO2/O2 concentration.
ReFactSet	Recover Factory Setting	To recover factory default settings and cancel any customized settings.
ESC	ESC	To indicate the CO2 leakage once the CO2 level is above the second alarm level.

	Hi	The CO2 concentration is above 5%, or the O2 concentration is Higher than 30%.
	Fan	If CO2 >CO2 Alarm Level or O2<O2 Alarm Level, fan will run.

4. SEU (Sensor Unit) Function Instruction

The SEU (Sensor Unit) should be placed in a room where the CO2 is likely to accumulate or O2 reduce, such as a room where CO2 is stored, like an area with CO2 beverages. The large LCD displays the ambient CO2 & O2 concentration.

The SEU has the "DIAG", "AL1", "AL2""CALI", "ReFactSet" function. The "DIAG" function executes communication tests between the SEU and RDU. The user can do the calibration under the "CALI" mode when necessary. If data-setting is done incorrectly, the user can use the "ReFactSet" back to the original factory setting.

There have "AL1" "AL2" two alarm levels, the alarm level is adjustable, the first alarm level of CO2 is with parameter 5000ppm, 1%, 1.5%, 2%, the default first alarm level is 1.5% ; the first alarm level of O2 is with parameter 18%, 18.5%, 19%, 19.5%, 20%, the default first alarm level is 19%. The second alarm level of CO2 is with parameter 1.5%, 2%, 2.5%, 3%, 3.5%, 4%, the default second alarm level is 3%; the second alarm level of O2 is with parameter 16%, 16.5%, 17%, 17.5%, 18%, the default second alarm level is 17%.

When the ZGa21 CO2 & O2 Monitor detects CO2 concentration exceeds the first alarm level or O2 concentration drops the first alarm level, the red 1 LED will blink and the buzzer will sound intermittently, the relay will be triggered. When CO2 concentration drops the first alarm level, or O2 concentration rise to the first alarm level, the red 1 LED will stop blinking and buzzer will stop beeping.

If the concentration of CO2 continues to rise above the second alarm level, or the concentration of O2 drops the second alarm level, the red 1 and red 2 LED's will flash together and the tempo of the buzzer will increase. When CO2 concentration drops below the second alarm level, even to the first alarm level, the red 1 and red 2 LED's will remain blinking, and the buzzer will remain beeping(This function is latch design. Based on DIN6653-2). Unless the ZGa21 is restarted, by means of reset button of ZGa21 or unplug the AC adaptor and reconnected it.

The green LED will light continuously when the power is normally supplied.

Warning: If the ambient CO2 concentration reaches the second alarm level on SEU & RDU, there will be a safety notice "ESC" displays on the LCD, Careful action, such as ventilating the space, must be taken before entering the room where the SEU is placed.

If the communication cable between the SEU & RDU doesn't connect well, like the communication cable looses in the Input port, the fault LED of SEU will blink, reconnect the cable, if the cable is inserted into the output port, on RDU, after one minute, the "Er7" will flash on LCD. Unplug the cable and plug it into the Input port. The unit will work normally after corrective action.

5. RDU (Remote Display Unit) Function Instruction

The RDU (Remote Display Unit) should be placed outside the room when in use. The RDU is connected to the SEU with a wire that has a maximum length of 8 meters (26 feet). The RDU should be placed where it can be conveniently observed before entering the room where the SEU is located. The RDU is a repeater, and displays the measurements made by the SEU on an easy-to-read digital LCD along with important safety information.

The RDU has "DIAG" function. The "DIAG" can test the communication between the SEU and RDU. Resetting the ZGa21 CO2 and O2 Monitor is only available from SEU.

6. Safety Note

Warning: Your safety is very important to us. To ensure to use the product correctly and safety, please read these warnings and the entire User Manual before using the product. Otherwise, the protection provided by the equipment may be impaired. These warnings provide important safety information and should be observed at all times.

1. Please handle the device carefully; do not subject the product to impact or shock. Otherwise, this may cause the accuracy drift.
2. Do not place the unit or the adaptor near a heat source. Heat can cause distortion of the unit, which may result in an explosion or fire.
3. Do not touch the exposed electronic circuitry of the device under any circumstances, as there is the dangerous of electric shocks.
4. Please use only the included power adaptor. Improper power adaptor or power sources can cause serious damage to the product, or result in injury or death to the user.

5. Please use the "DIAG" function to verify the communication between SEU and RDU, to make sure the communication between SEU and RDU works normally.
6. Please make sure that the power adaptor is mounted by plug lock tightly, so the power adaptor can not be disconnected without using of mechanical tools.
7. Do not enter into the room directly if there has safety notice "ESC" displays on the LCD of SEU & RDU. Some careful and protective action must be taken before entering the room where the SEU is installed.
8. Please take care of cable connection between SEU and RDU. Make sure the cable from SEU is connected into the INPUT port of RDU.
9. Please ensure the external power supply is normally supplied to ventilation fan while the relay is working. If there has no normally power supply to the fan, the relay will not work, which may result in potential danger with high CO2 concentration or low O2 concentration in confined space.

7. Caring For Product

To make sure to receive the maximum benefit from using this product, please observe the follow guidelines.

1. Repair - Do not attempt to repair the product or modify the circuitry by yourself. Please contact your local dealer or a qualified repairman if the product needs servicing, including the replacement or calibration of sensor.
2. Note: The oxygen sensor must be replaced every 3 years.
3. Cleaning - Disconnect the power before cleaning. Use a damp cloth. Do not use liquid cleaning agents such as benzene, thinner or aerosols, as these will damage the device.
4. Maintenance – We recommend users to test the communication between the SEU and RDU under "DIAG" function to verify the working conditions or the SEU and RDU. If the four LED's blink and the buzzer of SEU and RDU sound simultaneously, it indicates that SEU and RDU work normally.

When the LCD displays a safety icon "ESC", please take immediate protective action to check if CO2 leakage has occurred. We suggest users to do the calibration and thorough function check once within two years to make sure that the ZGa21 CO2 and O2 Monitor is working properly.

8. Installation Instruction

Please carefully take out the SEU (Sensor Unit), RDU (Remote Display Unit), panel holders, network cable connector, 7 meters communication cable, user manual, plug lock, screws, expansion plugs, nail cable clips, warning paper from the package.

Step-by-Step Installation:

1. Choose a suitable location to install the SEU. Fix the panel holder on the wall with the four screws (included); the recommend installation height is about 0.45 meters (1.5 feet) from floor and close to the manifolds and valves as possible.
2. Put the SEU on the panel holder, making sure that they are connected tightly.
3. Fix another panel holder in a suitable location outside the monitored space with screws (included). Push the RDU onto panel holder, and stick the warning paper next to RDU.
4. The communication cable is pre-wired to the SEU. Route the cable to the RDU and fixed the communication cable to the wall by nail cable clips, and then plug the cable into the input port on the RDU. Communication is now ready between the SEU and RDU.
5. The ZGa21 CO2 and O2 Monitor has two relay output: one is for CO2 and the other is for O2. The relay cable is pre-wired to SEU. The relay can control a fan or blower to ventilate the monitored space when necessary and the relay will be triggered when the CO2 concentration exceeds the first alarm level or O2 concentration drops the first alarm level.
6. After finishing the installation, Connected the AC power adaptor into the electrical supply outlet. Mount the Plug lock by expansion plugs so that the power adaptor cannot be disconnected without use of mechanical tools.
7. When the power has been connected, The SEU and the RDU will begin to work. Please use the "DIAG" function to verify the communication between SEU and RDU, the four LED's will blink and buzzer will sound on SEU & RDU, after that the communication is ready, the content of display is same on SEU & RDU.

Mount the plug lock

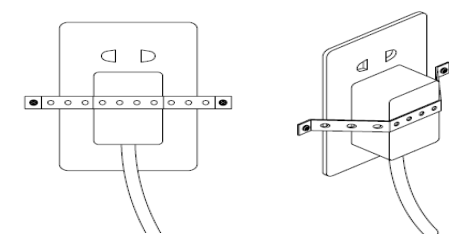

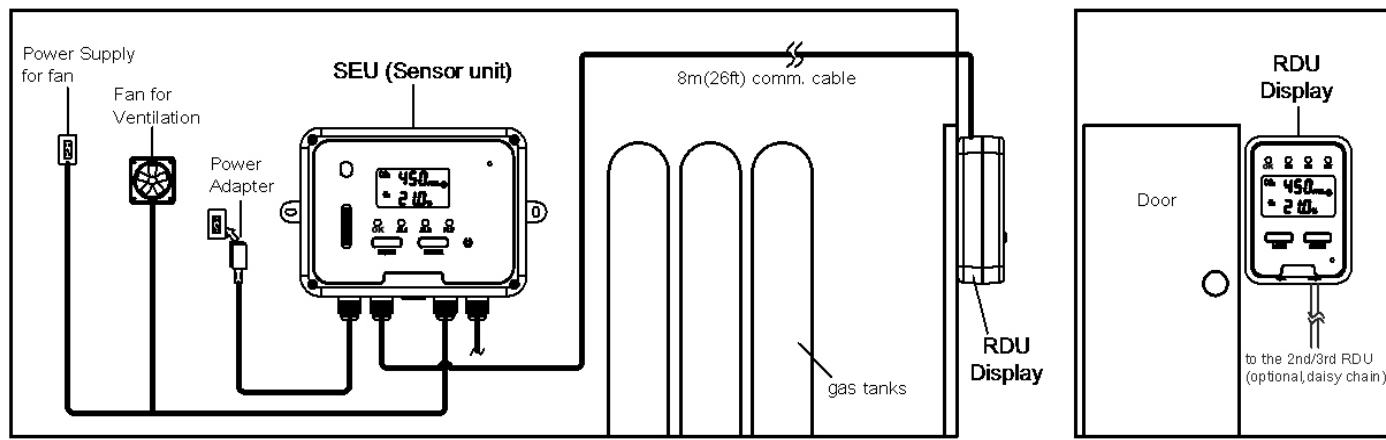

9. Customizing Settings

When power has been connected, the SEU and RDU will begin to monitor the CO₂ & O₂ concentration. In order to get the timely alarm safety information and meet the personal requirements, it is advisable to set up the customizing parameter when necessary.

Temperature °C/°F:

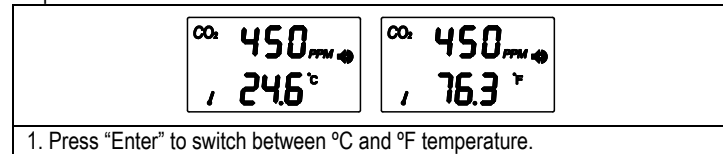

1. Press "Enter" to switch between °C and °F temperature.

Using the DIAG function:

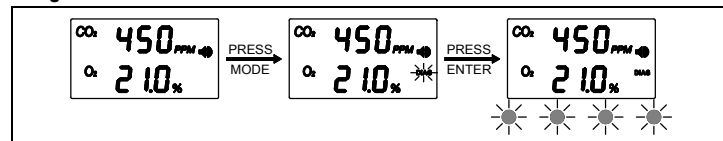

1. Press Mode until the "DIAG" icon flashes
2. Press Enter, the four LED's will blink on the SEU and the buzzer will sound
3. The four LED's will blink and buzzer will sound simultaneously on the RDU

Setting the CO₂ First Alarm parameter:



1. Press Mode until the "AL1" icon flashes
2. Press Enter, the "AL1" icon shows on LCD
3. Press Mode to go through "5000ppm, 1%, 1.5%, 2%" alarm level
4. Press Enter again to save the setting after selection

Setting the CO₂ Second Alarm parameter:



1. Press Mode until the "AL2" icon flashes
2. Press Enter, the "AL2" icon shows on LCD
3. Press Mode to go through "1.5%, 2%, 2.5%, 3%, 3.5%, 4%" alarm level
4. Press Enter again to save the setting after selection

Note: The second alarm level should be higher than the first alarm level when setting with the alarm level parameter.

Setting the O₂ First Alarm parameter:

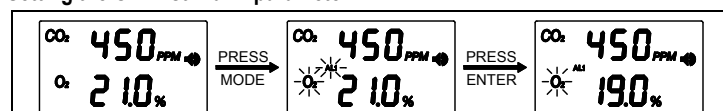

1. Press Mode until the "AL1" icon flashes
2. Press Enter, the "AL1" icon shows on LCD
3. Press Mode to go through "18%, 18.5%, 19%, 19.5%, 20%" alarm level
4. Press Enter again to save the setting after selection

Setting the O₂ Second Alarm parameter:

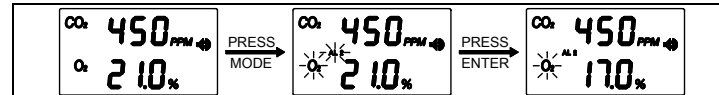

1. Press Mode until the "AL2" icon flashes
2. Press Enter, the "AL2" icon shows on LCD
3. Press Mode to go through "16%, 16.5%, 17%, 17.5%, 18%" alarm level
4. Press Enter again to save the setting after selection

Note: The second alarm level should be lower than the first alarm level when setting with the alarm level parameter.

Using the CO₂ CALI function:

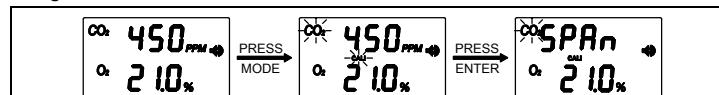

1. Press Mode until the "CALI" icon flashes.
2. Press Enter, the "CALI" and "ZZero" icons show on the LCD. Press and hold Mode for at least 10 seconds, "CALIBRATING" and "ZZero" icons will flash simultaneously. The calibration will be done automatically. After about 3 minutes the LCD will display "Pass" or "Fail". If "Fail", please try again.
3. Press Enter, the "CALI" and "SPAN" icons show on the LCD, press and hold Mode for at least 10 seconds, "CALIBRATING" and "SPAN" icon will flash simultaneously and the calibration will be done automatically. After about 3 minutes the LCD will display "Pass" or "Fail". If "Fail", please try again.

Note: When do the calibration,

When do the "ZZero" Calibration, please enter through N₂.

When do the "SPAN" Calibration, please enter through 4% CO₂ gas.

Before doing "ZZero"/"SPAN" calibration, it will take about 5 min to enter through CO₂ to stabilize.

When do "ZZero"/"SPAN" calibration, the reading is beating too often and calibration fails.

Using the O₂ CALI function:

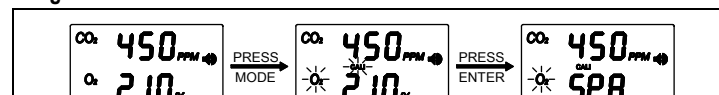

1. Press Mode until the "AL1" icon flashes
2. Press Enter, the "AL1" icon shows on LCD
3. Press Mode to go through "18%, 18.5%, 19%, 19.5%, 20%" alarm level
4. Press Enter again to save the setting after selection

The O₂ CALI function is as same as CO₂'s.

Note: When do the calibration,

When do the "ZEr" Calibration, please enter through N₂.

When do the "SPA" Calibration, please enter through 21% O₂ gas.

Before doing "ZEr"/"SPA" calibration, it will take about 5 min to enter through O₂ to stabilize.

When do "ZEr"/"SPA", the reading is beating too often and calibration fails.

Using the ReFactSet function:

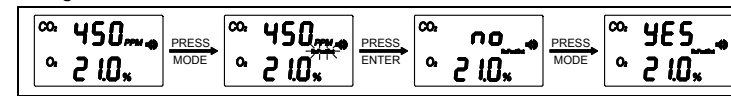

1. Press Mode until the "ReFactSet" icon flashes.
2. Press Enter, and then press Mode to choose either "Yes" or "No".
3. Press Enter again to save the setting after selecting.

Note: If the user sets the data or calibrates the sensor incorrectly, use the ReFactSet (recover the factory Setting) to come back the default factory setting.

10. Specification

CO₂ & O₂ Temperature specification:

CO ₂ & O ₂ Specification	
Measurement Range	CO ₂ : 0 - 50,000ppm (5%) display O ₂ : 0- 30% display
Display Resolution	CO ₂ : 10ppm at 0~10,000ppm; 100ppm at 10,001~50,000ppm O ₂ : 0.1%
Accuracy	CO ₂ : ±100ppm or ±5% of reading, whichever is greater O ₂ : Better than ± 3% of FS over 0.1 to 30%
Repeatability	CO ₂ : ±20ppm @400ppm O ₂ : Less than ±1.0%
Temperature Dependence	±0.3% of reading per °C or ±2ppm per °C, whichever is greater, referenced to 25°C
Pressure Dependence	0.13% of reading per mm Hg
Response Time	CO ₂ : <60 seconds for 90% response to step change O ₂ : <30 seconds for 90% response to step change
AL1 (First Alarm Level)	CO ₂ : 5000ppm, 1 / 1.5 / 2 % , Default AL1= 1.5% O ₂ : 18%, 18.5%, 19%, 19.5%, 20%, Default AL1=19%
AL2 (Second Alarm Level)	CO ₂ : 1.5 / 2 / 2.5 / 3 / 3.5 / 4 % , Default AL2= 3% O ₂ : 16%, 16.5%, 17%, 17.5%, 18%, Default AL2=17%
Sound Alarm	80db@10cm
Warm-Up Time	<60 seconds at 22°C
Temperature Specification:	
Temperature Range	0°C to 50°C (32°F to 122°F)
Display Resolution	0.1°C (0.1°F)
Display Options	°C/°F
Accuracy	±1°C(±2°F) when CO ₂ concentration is below first alarm level
Response Time	20-30 minutes (case must equalize with environment)
Operating Conditions:	
Operating Temperature	0°C to 40°C (32°F to 104°F)
Humidity Range	0 ~ 95% RH non-condensing
Storage Conditions:	
Storage Temperature	-20°C to 60 °C (-4°F to 140°F)

Power Supply & Relay Output:

Power Supply	AC adapter 110/220 VAC	
AC Input	Voltage	100 ~ 240 VAC
	Frequency	50 / 60 Hz
AC/DC Output	Voltage	6VDC
	Power	3.0 W
Peak Input Current	0.5 A from 6 VDC	
Analog output	Two channel linear current output: 4~20mA for O ₂ , RL<150Ω; 4~20mA for CO ₂ , RL<150Ω.	
Relay Output	Two Relay output: Relay 1 operates at alarm 1 for CO ₂ or O ₂ , Relay 2 operates at alarm 2 for CO ₂ or O ₂ . Peak Current< 2A@30 VDC or 250 VAC,SPDT.	

11. Relay output

There are two relay output for this item. Relay 1 operates at alarm 1 for CO₂ or O₂, Relay 2 operates at alarm 2 for CO₂ or O₂. The relay 1 will be triggered when CO₂ concentration exceeds the first alarm level or O₂ concentration drops the first alarm level. The relay 2 will be triggered when CO₂ concentration exceeds the second alarm level or O₂ concentration drops the second alarm level.

12. Weight & Dimension

Weight: SEU (Sensor Unit):1200 g (include cables)
RDU (Remote Display Unit): 120 g

Dimension:
SEU (Sensor Unit)

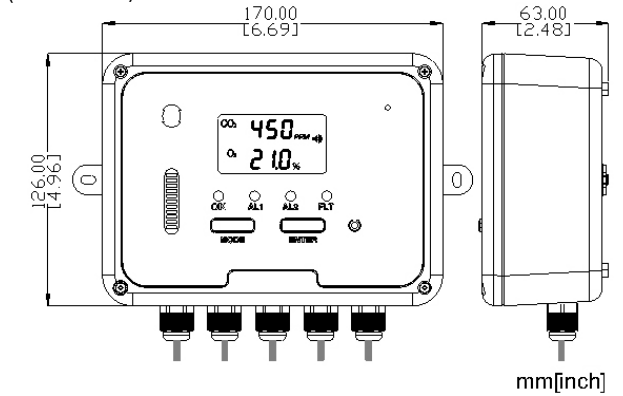

RDU (Remote Display Unit)

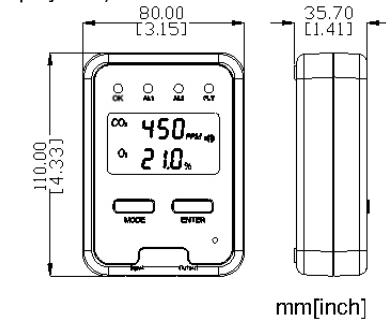

13. Fault Codes & Troubleshooting Guide

This section includes a list of Frequently Asked Questions for problems you may encounter with the ZGa21 CO₂ & O₂ Monitor.

No	LCD Fault Icon	Description (of the fault)	SEU Indication	RDU Indication	Suggested Actions
1	Er3	The ambient temperature has exceeded the temperature range 0°C to 50°C (32°F to 122°F)	"Er3" flash Fault LED blink, Buzzer beep	"Er3" flash Fault LED blink, Buzzer beep	This error will disappear when the temperature returns to the range between 0°C and 50°C (32°F to 122°F)
2	Er4	some wrong measurement or the sensor has exceeded its expected life	"Er4" flash Fault LED blink, Buzzer beep	"Er7" flash Fault LED blink, Buzzer beep	Please unplug the AC adapter and reconnect it. If the "Er4" always appears, please contact with the local dealer.
3	Er5 Er6	EEPROM System Problem	"Er5" & "Er6" flash, Fault LED blink, Buzzer beep	"Er7" flash Fault LED blink, Buzzer beep	Please unplug the AC adapter and reconnect it. If the "Er5, Er6" always appear, please contact with the local dealer.
4	Er7	Internal Data Transmission Error	"Er7" flash, Fault LED blink, Buzzer beep	"Er7" flash, Fault LED Blink, Buzzer beep	① Please unplug the AC adapter and reconnected it. ② Check the RJ45 plug is connected into the INPUT port of RDU, if the "Er7" displays on the RDU only.
5	Er8	The accuracy of CO ₂ & O ₂ sensor may deviate from the actual concentration.	"Er8" flash Fault LED blink, Buzzer beep	"Er8" flash Fault LED blink, Buzzer beep	① Please unplug the AC adapter and reconnect it if the "Er8" still appears, please contact with the local dealer. ② Please calibrate the unit, after the calibration, if the "Er8" still appears, please contact with the local dealer.

ZyAura
Monitoring the invisible

Radiant Innovation Inc. <http://www.ZyAura.com>
1F, No.3, Industrial East 9th Road, Science-Based Industrial Park,
HsinChu, Taiwan 300.